

## LM733/LM733C Differential Amplifier

### General Description

The LM733/LM733C is a two-stage, differential input, differential output, wide-band video amplifier. The use of internal series-shunt feedback gives wide bandwidth with low phase distortion and high gain stability. Emitter-follower outputs provide a high current drive, low impedance capability. Its 120 MHz bandwidth and selectable gains of 10, 100 and 400, without need for frequency compensation, make it a very useful circuit for memory element drivers, pulse amplifiers, and wide band linear gain stages.

The LM733 is specified for operation over the  $-55^{\circ}\text{C}$  to  $+125^{\circ}\text{C}$  military temperature range. The LM733C is specified for operation over the  $0^{\circ}\text{C}$  to  $+70^{\circ}\text{C}$  temperature range.

### Features

- 120 MHz bandwidth
- 250 k $\Omega$  input resistance
- Selectable gains of 10, 100, 400
- No frequency compensation
- High common mode rejection ratio at high frequencies

### Applications

- Magnetic tape systems
- Disk file memories
- Thin and thick film memories
- Woven and plated wire memories
- Wide band video amplifiers

### Connection Diagrams

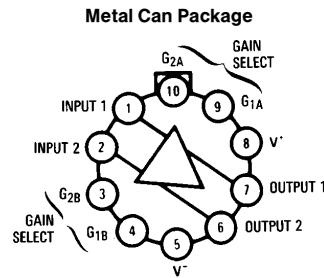
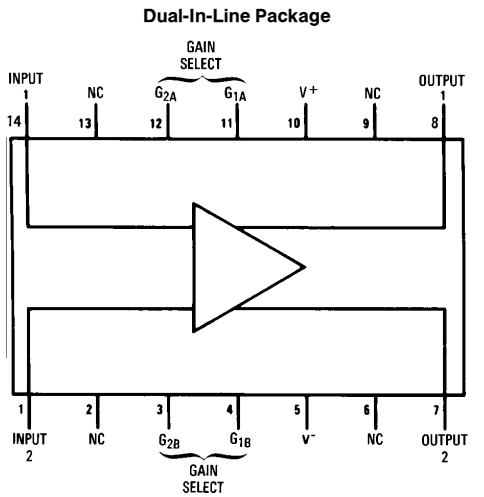

Note: Pin 5 connected to case.

**Top View**  
Order Number LM733H or LM733CH  
See NS Package Number H10D

## Absolute Maximum Ratings

If Military/Aerospace specified devices are required, please contact the National Semiconductor Sales Office/Distributors for availability and specifications.

Differential Input Voltage	±5V
Common Mode Input Voltage	±6V
V <sub>CC</sub>	±8V
Output Current	10 mA

Power Dissipation (Note 1)	500 mW
Junction Temperature	+150°C
Storage Temperature Range	–65°C to +150°C
Operating Temperature Range	
LM733	–55°C to +125°C
LM733C	0°C to +70°C
Lead Temperature (Soldering, 10 sec.)	260°C

## Electrical Characteristics (T<sub>A</sub> = 25°C, unless otherwise specified, see test circuits, V<sub>S</sub> = ±6.0V)

Characteristics	Test Circuit	Test Conditions	LM733			LM733C			Units
			Min	Typ	Max	Min	Typ	Max	
Differential Voltage Gain									
Gain 1 (Note 2)	1	R <sub>L</sub> = 2 kΩ V <sub>OUT</sub> = 3 Vp-p	300	400	500	250	400	600	
Gain 2 (Note 3)			90	100	110	80	100	120	
Gain 3 (Note 4)			9.0	10	11	8.0	10	12	
Bandwidth									
Gain 1	2			40			40		MHz
Gain 2				90			90		MHz
Gain 3				120			120		MHz
Rise Time									
Gain 1	2	V <sub>OUT</sub> = 1 Vp-p		10.5			10.5		ns
Gain 2				4.5	10		4.5	12	ns
Gain 3				2.5			2.5		ns
Propagation Delay									
Gain 1	2	V <sub>OUT</sub> = 1 Vp-p		7.5			7.5		ns
Gain 2				6.0	10		6.0	10	ns
Gain 3				3.6			3.6		ns
Input Resistance									
Gain 1			20	4.0			4.0		kΩ
Gain 2				30		10	30		kΩ
Gain 3				250			250		kΩ
Input Capacitance		Gain 2		2.0			2.0		pF
Input Offset Current				0.4	3.0		0.4	5.0	μA
Input Bias Current				9.0	20		9.0	30	μA
Input Noise Voltage		BW = 1 kHz to 10 MHz		12			12		μVrms
Input Voltage Range	1		±1.0			±1.0			V
Common Mode Rejection Ratio									
Gain 2	1	V <sub>CM</sub> = ±1V f ≤ 100 kHz	60	86		60	86		dB
Gain 2		V <sub>CM</sub> = ±1V f = 5 MHz		60			60		dB
Supply Voltage Rejection Ratio									
Gain 2	1	ΔV <sub>S</sub> = ±0.5V	50	70		50	70		dB
Output Offset Voltage									
Gain 1	1	R <sub>L</sub> = ∞		0.6	1.5		0.6	1.5	V
Gain 2 and 3				0.35	1.0		0.35	1.5	V
Output Common Mode Voltage	1	R <sub>L</sub> = ∞	2.4	2.9	3.4	2.4	2.9	3.4	V
Output Voltage Swing	1	R <sub>L</sub> = 2k	3.0	4.0		3.0	4.0		
Output Sink Current			2.5	3.6		2.5	3.6		mA
Output Resistance				20			20		Ω
Power Supply Current	1	R <sub>L</sub> = ∞		18	24		18	24	mA

## Electrical Characteristics (Continued)

(The following specifications apply for  $-55^{\circ}\text{C} < T_A < 125^{\circ}\text{C}$  for the LM733 and  $0^{\circ}\text{C} < T_A < 70^{\circ}\text{C}$  for the LM733C,  $V_S = \pm 6.0\text{V}$ )

Characteristics	Test Circuit	Test Conditions	LM733			LM733C			Units
			Min	Typ	Max	Min	Typ	Max	
Differential Voltage Gain Gain 1 Gain 2 Gain 3	1	$R_L = 2\text{ k}\Omega, V_{OUT} = 3\text{ V}_{p-p}$	200 80 8.0		600 120 12.0	250 80 8.0	600 120 12.0		
Input Resistance Gain 2			8			8		$\text{k}\Omega$	
Input Offset Current					5		6	$\mu\text{A}$	
Input Bias Current					40		40	$\mu\text{A}$	
Input Voltage Range	1		$\pm 1$			$\pm 1$		V	
Common Mode Rejection Ratio Gain 2	1	$V_{CM} = \pm 1\text{ V } f \leq 100\text{ kHz}$	50			50		dB	
Supply Voltage Rejection Ratio Gain 2	1	$\Delta V_S = \pm 0.5\text{ V}$	50			50		dB	
Output Offset Voltage Gain 1 Gain 2 and 3	1	$R_L = \infty$			1.5 1.2		1.5 1.5	V V	
Output Voltage Swing	1	$R_L = 2\text{ k}$	2.5			2.8		$V_{pp}$	
Output Sink Current			2.2			2.5		mA	
Power Supply Current	1	$R_L = \infty$			27		27	mA	

**Note 1:** The maximum junction temperature of the LM733 is  $150^{\circ}\text{C}$ , while that of the LM733C is  $100^{\circ}\text{C}$ . For operation at elevated temperatures devices in the TO-100 package must be derated based on a thermal resistance of  $150^{\circ}\text{C}/\text{W}$  junction to ambient or  $45^{\circ}\text{C}/\text{W}$  junction to case. Thermal resistance of the dual-in-line package is  $90^{\circ}\text{C}/\text{W}$ .

**Note 2:** Pins G1A and G1B connected together.

**Note 3:** Pins G2A and G2B connected together.

**Note 4:** Gain select pins open.

**Note 5:** Refer to RETS733X drawing for specifications of LM733H version.

## Typical Performance Characteristics

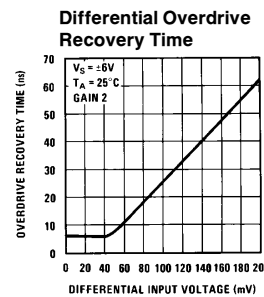
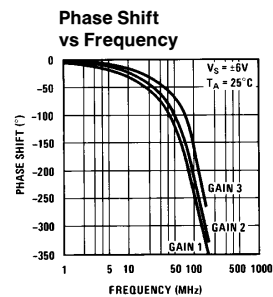
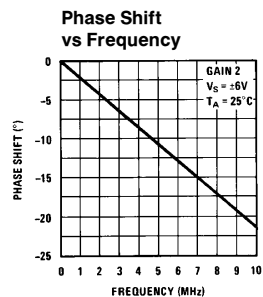
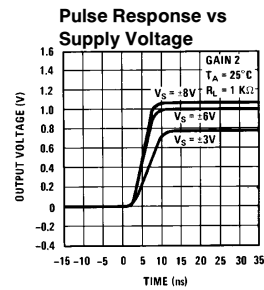
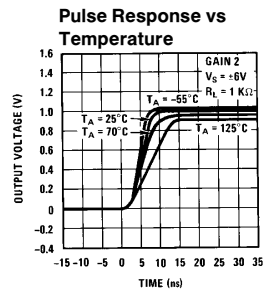
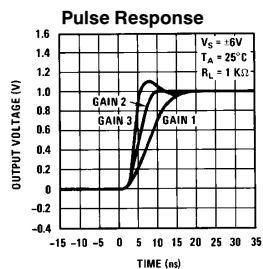

TL/H/7866-6

# Typical Performance Characteristics (Continued)

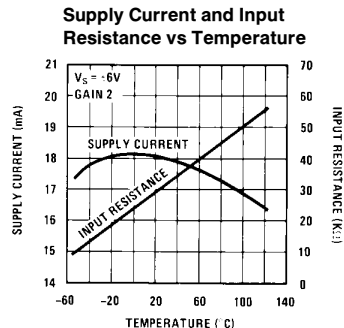
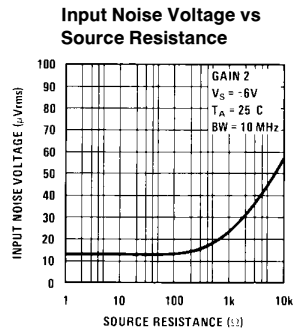
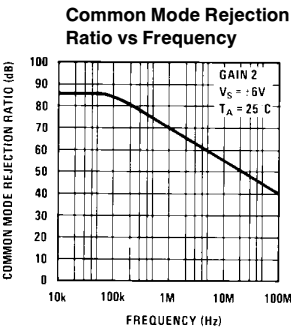
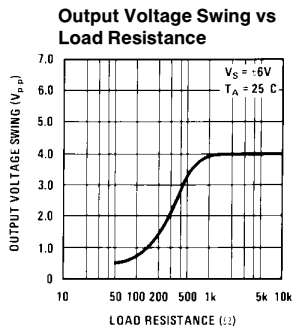
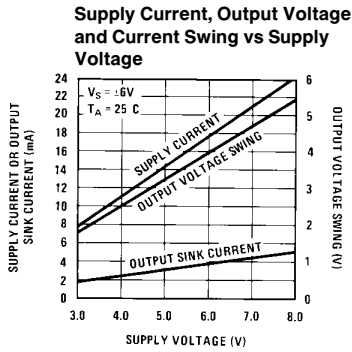
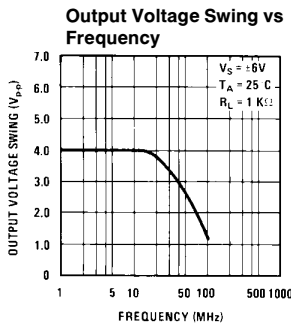
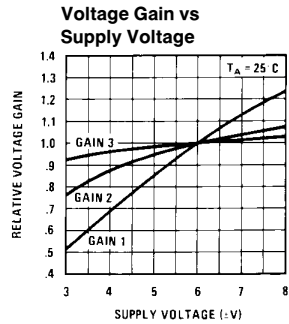
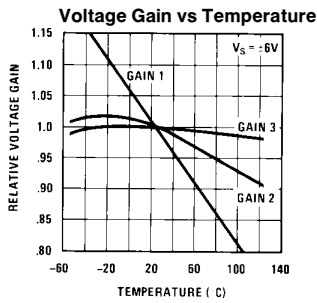
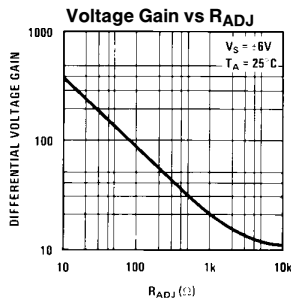
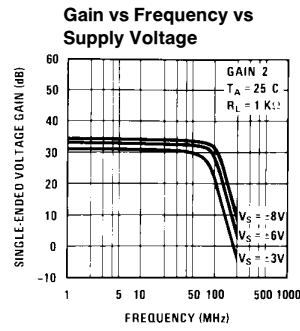
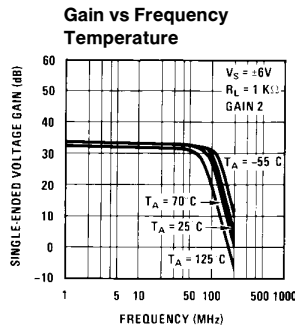
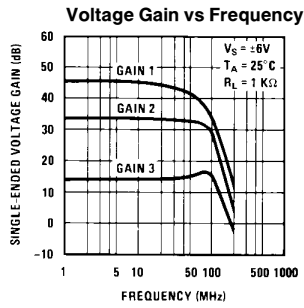

TL/H/7866-7

## Test Circuits

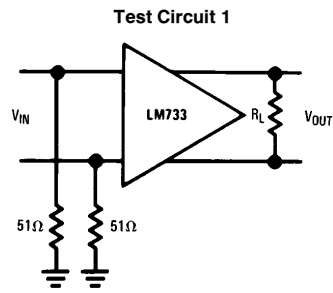

TL/H/7866-3

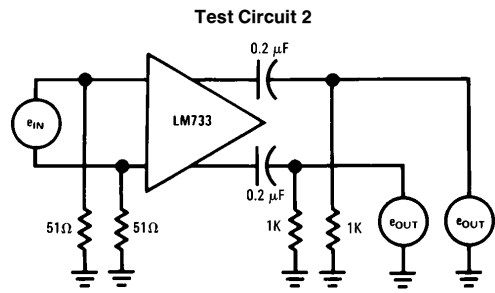

TL/H/7866-4

### Voltage Gain Adjust Circuit

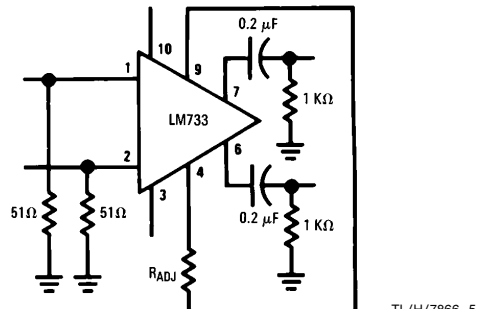

TL/H/7866-5

$V_S = 6V, T_A = 25^\circ C$   
(Pin numbers apply to TO-5 package)

## Schematic Diagram

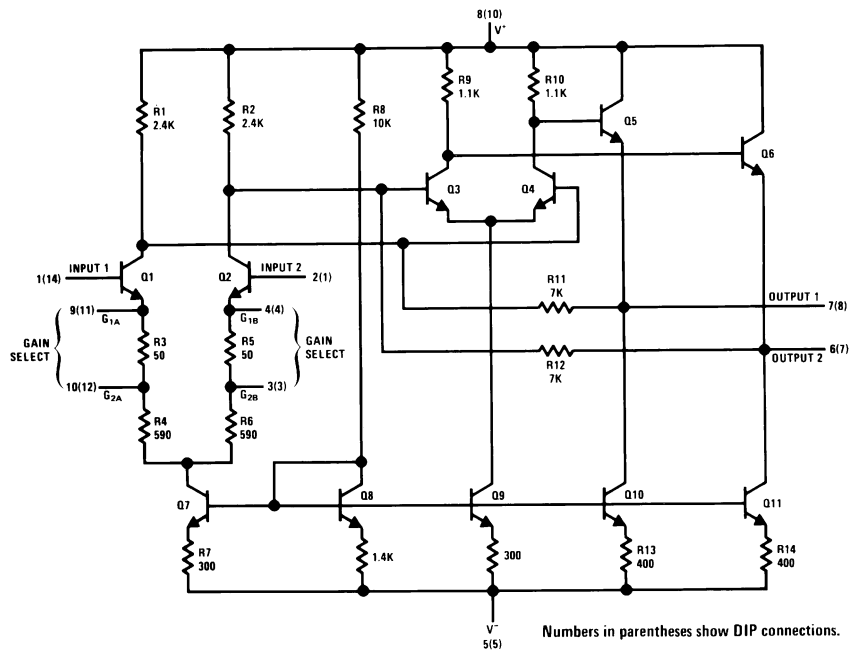

TL/H/7866-8

**Physical Dimensions** inches (millimeters)

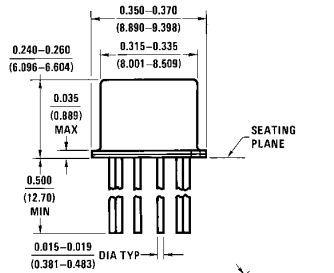

**Metal Can Package (H)**  
**Order Number LM733H or LM733CH**  
**NS Package Number H10D**

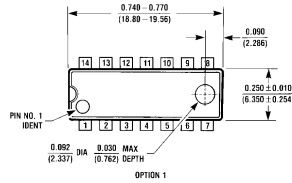
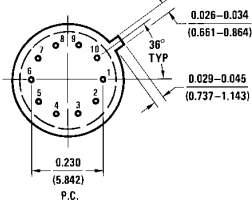

H10D (REV B)

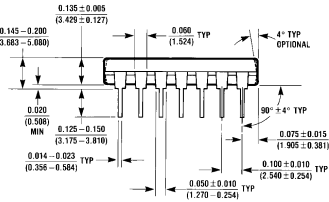
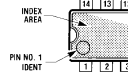

OPTION 02

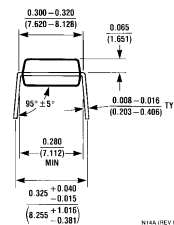

N14A (REV F)

**Molded Dual-In-Line Package (N)**  
**Order Number LM733CN**  
**NS Package Number N14A**

**LIFE SUPPORT POLICY**

NATIONAL'S PRODUCTS ARE NOT AUTHORIZED FOR USE AS CRITICAL COMPONENTS IN LIFE SUPPORT DEVICES OR SYSTEMS WITHOUT THE EXPRESS WRITTEN APPROVAL OF THE PRESIDENT OF NATIONAL SEMICONDUCTOR CORPORATION. As used herein:

1. Life support devices or systems are devices or systems which, (a) are intended for surgical implant into the body, or (b) support or sustain life, and whose failure to perform, when properly used in accordance with instructions for use provided in the labeling, can be reasonably expected to result in a significant injury to the user.
2. A critical component is any component of a life support device or system whose failure to perform can be reasonably expected to cause the failure of the life support device or system, or to affect its safety or effectiveness.



**National Semiconductor Corporation**  
 1111 West Bardin Road  
 Arlington, TX 76017  
 Tel: 1(800) 272-9959  
 Fax: 1(800) 737-7018

**National Semiconductor Europe**  
 Fax: (+49) 0-180-530 85 86  
 Email: cnjwge@tevm2.nsc.com  
 Deutsch Tel: (+49) 0-180-530 85 85  
 English Tel: (+49) 0-180-532 78 32  
 Français Tel: (+49) 0-180-532 93 58  
 Italiano Tel: (+49) 0-180-534 16 80

**National Semiconductor Hong Kong Ltd.**  
 19th Floor, Straight Block,  
 Ocean Centre, 5 Canton Rd.  
 Tsimshatsui, Kowloon  
 Hong Kong  
 Tel: (852) 2737-1600  
 Fax: (852) 2736-9960

**National Semiconductor Japan Ltd.**  
 Tel: 81-043-299-2309  
 Fax: 81-043-299-2408

National does not assume any responsibility for use of any circuitry described, no circuit patent licenses are implied and National reserves the right at any time without notice to change said circuitry and specifications.